



118 GST-SUB

The 118 GST-Sub was designed to provide an optimized bandwidth response for the P Audio GST 181500 and the GST 181200. The 118 GST-Sub is a single element vented design that will provide deep bass and high sound pressure level performance to the lowest response range of the GST 18 inch woofers. The 118 GST-Sub is a medium format design that is very portable and can be used in both indoor environments and easily used in multiple enclosure configurations for outdoor, non permanent install venues. The enclosure provides ultimate performance when constructed with high quality void free plywood.

The 118 GST-Sub design includes full enclosure plans. Additional enclosure construction tips and recommendations can be found in the P Audio document titled "Enclosure Construction Tips".

The 118 GST-Sub can be fully optimized by using a high quality DSP based loudspeaker processor. The recommended high pass filter is a 4th order Butterworth (24dB/Oct) with a corner frequency of 38Hz. When the 118 GST-Sub is loaded with either the GST 181500 or the GST 181200 high performance woofers the recommended low pass filter (high frequency crossover) is a 4th order Linkwitz-Riley with a crossover frequency of between 80Hz and 120 Hz.



CUT AWAY



FRONT VIEW



BACK VIEW

PART LIST

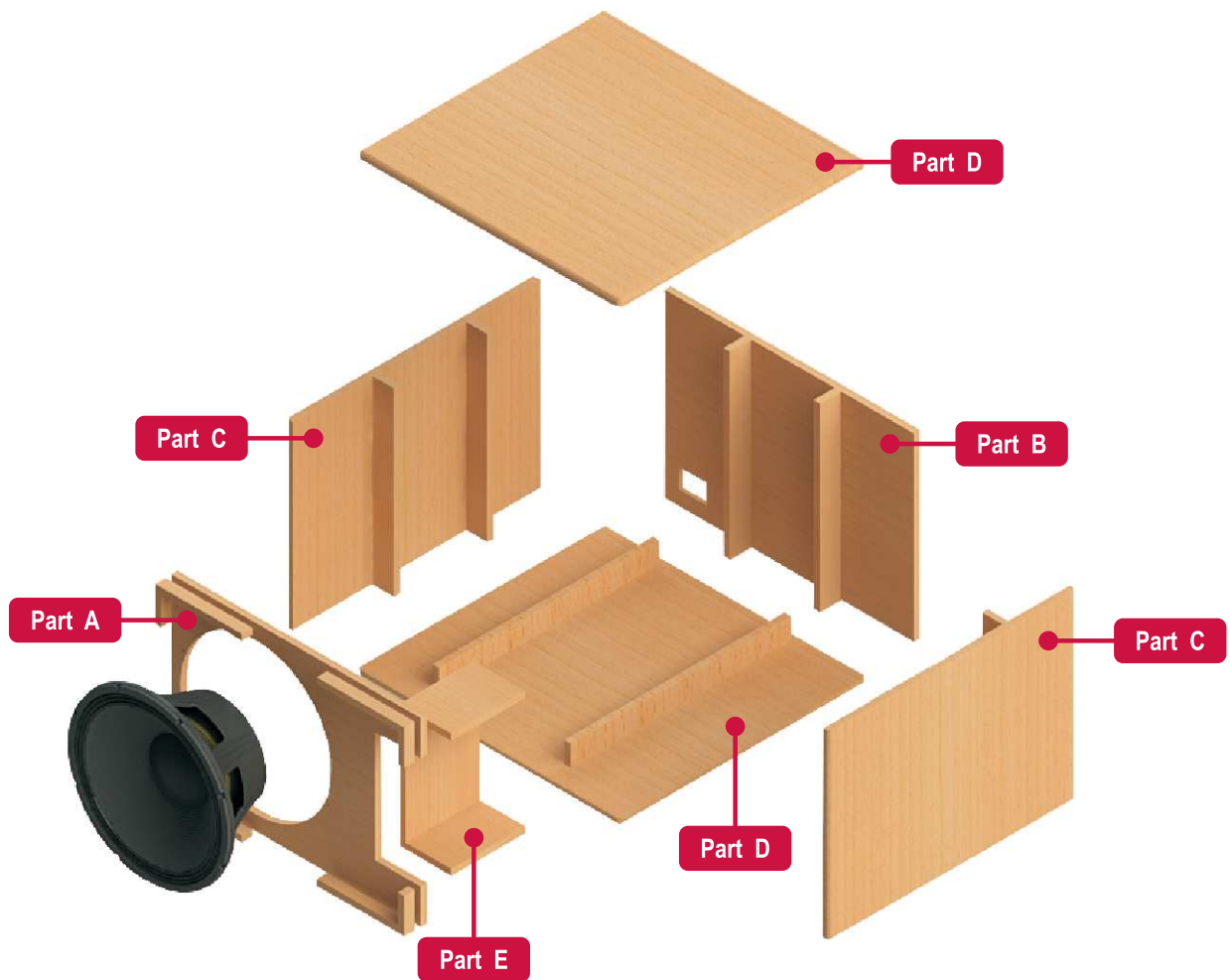

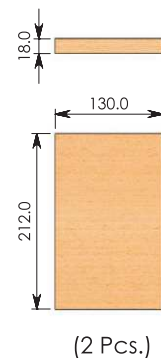
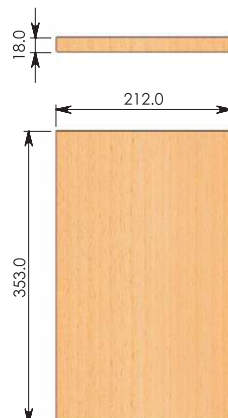
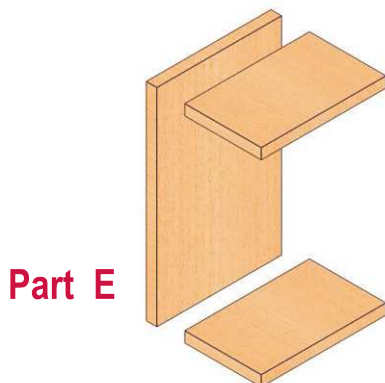
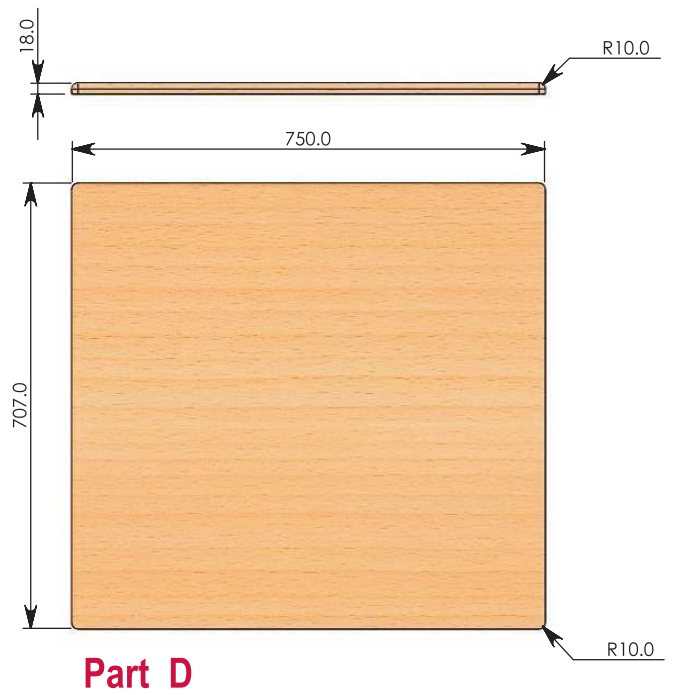
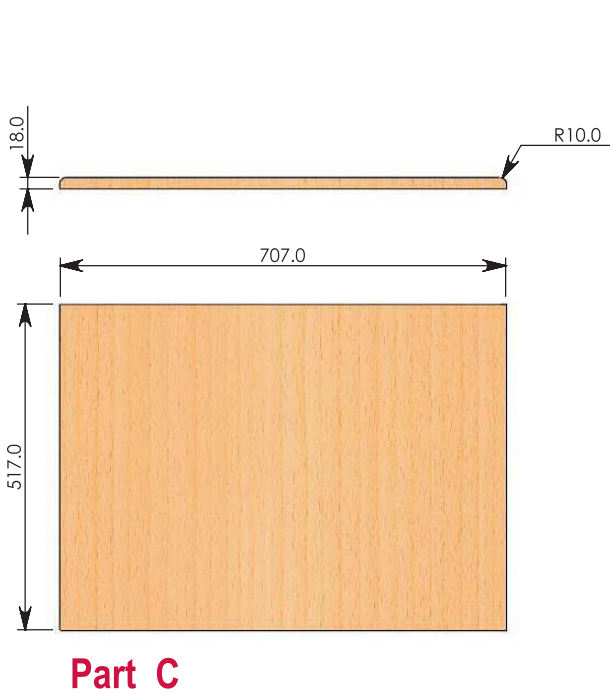
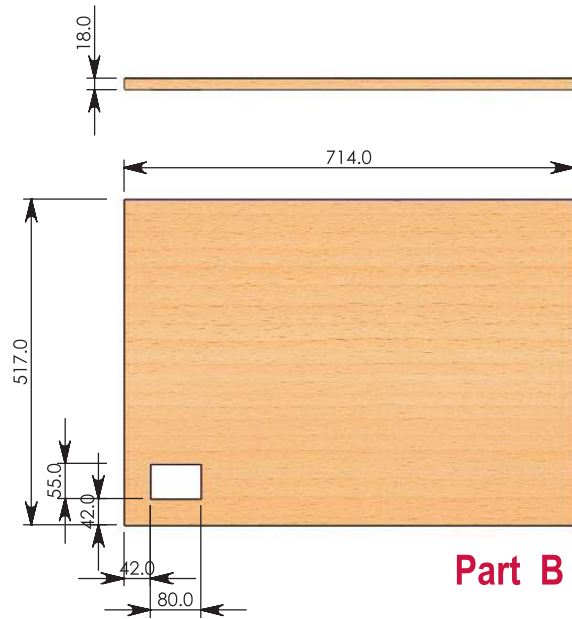
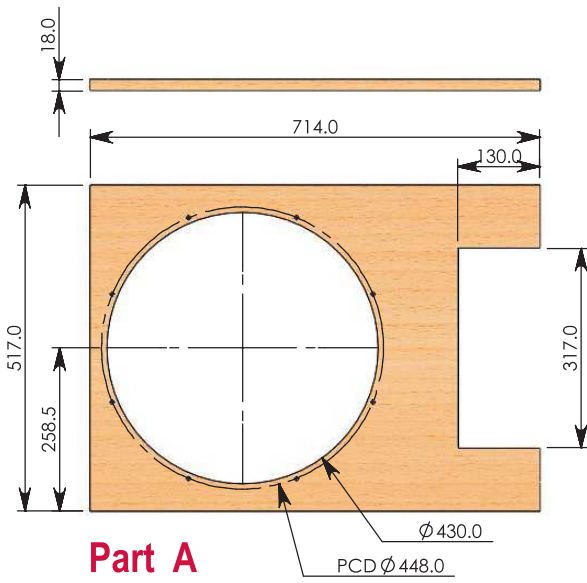

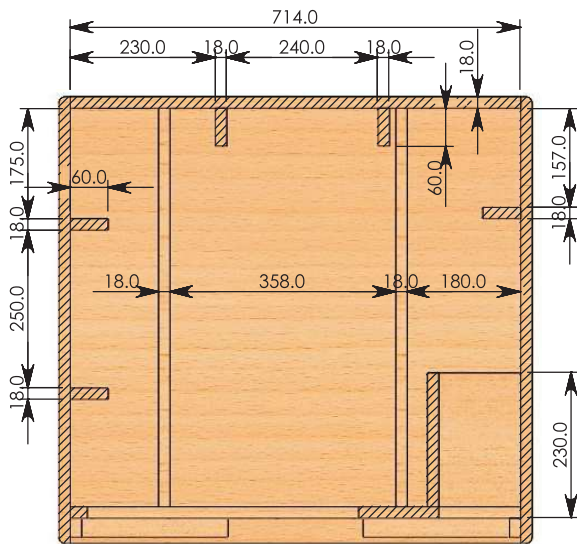
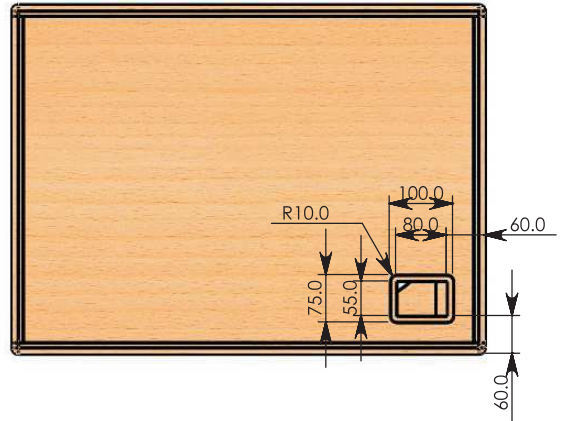
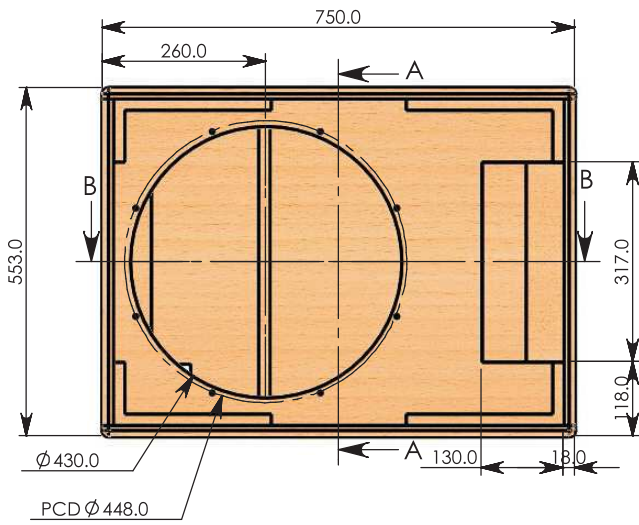

SECTION B-B

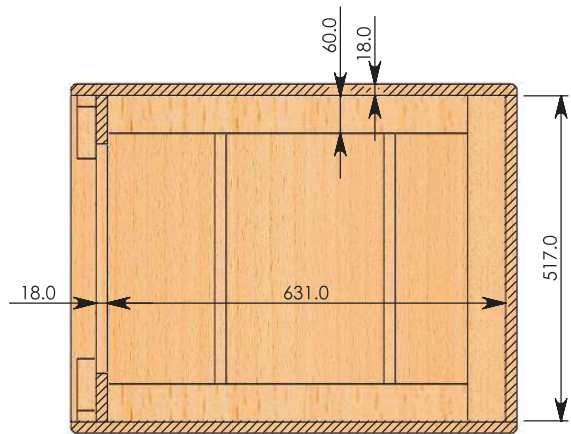

SECTION A-A

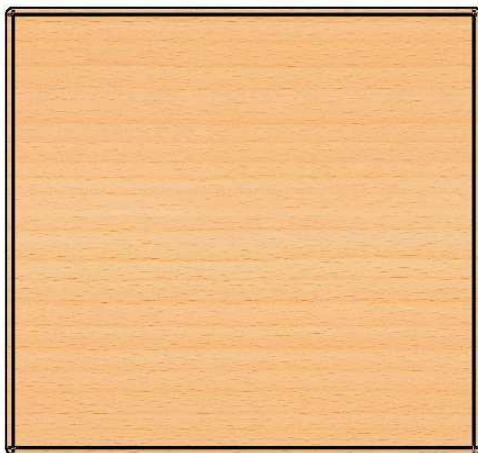

TOP VIEW

